

High gain 24 element Yagi antenna for 23cm

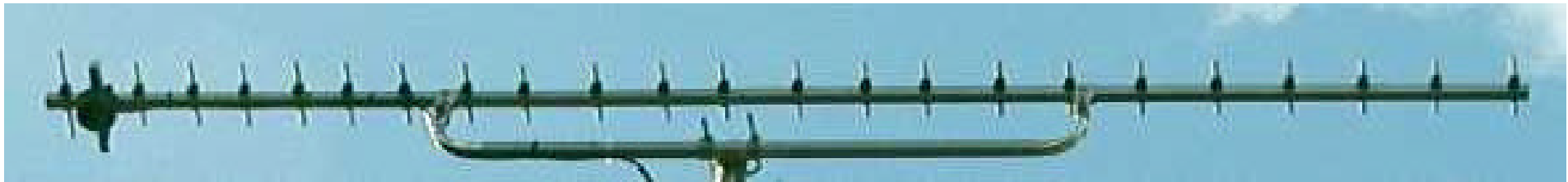

Introduction

This document describes a high gain Yagi antenna optimised to cover the whole of the 23cm amateur radio band (1240 - 1320MHz). It contains several unique design features which combine to give high gain, low VSWR and outstanding performance across a remarkably wide bandwidth.

Constructional notes

The elements (which can be 6mm tube or preferably solid rod) are mounted using proprietary 'saddles' which raise them 2mm above the boom. The elements are secured using stainless steel Pozidrive screws size 2.9mm x 13mm). The screw and the spacing of the element above the boom are an integral part of the antenna design.

The terminal box is a small plastic case of approximately 40x35mm internal dimensions (e.g. Farnell 326-161). If a standard 'TV' style termination box is used, remove ALL internal structures to allow the balun PCB to fit flush. The particular size and shape of the pads on the PCB are integral to the design of the antenna and compensate for the boom capacity loading of the balun circuit. Two self-tapping screws through the PCB and terminal box provided a fixing to the boom. If you use a plastic box (rather than a TV aerial terminal box) then a 1.6mm spacer is required between the bottom of the box and the boom. A suitable spacer is a piece of PCB with ALL copper removed. Two stainless steel M3 bolts with 'Nylok' nuts (or normal nut and lock washer) fix the ends of the folded dipole to the termination PCB (mount the bolts so the screw heads are inside the box). A self-tapping screw is used on the opposite side of the boom to fix the centre of the folded dipole. A M3 stainless steel bolt with 'Nylok' nut (or normal nut and lock washer) fix the 'tag' to the rest of the folded dipole assembly. If 'TV' style booms are used a 2-3mm spacer (metal or plastic) may be required between the boom and the folded dipole at the centre fixing point.

The 1/2 wave 'balun' co-ax is looped between the two outer termination points. Solder the centre core to the two outer pads, and solder the braid to the centre pad. CAREFULLY bend the co-ax (round a screwdriver or similar) to enable it to be fitted within the terminal box.

Connect the feed co-ax braid to the centre pad and the core to either of the outer pads. Use a good quality co-axial feed: do not use RG58! RG213 or, failing that, UR67 is OK for a SHORT length (a couple of feet) but we recommend a decent cable like LMR400. You may even consider a short length of semi-rigid cable to connect to an N type socket.

Make sure that the co-ax braids and cores do not short, then close the box lid.

Conditions of use

This antenna, and its unique design features, are released for use by amateur radio enthusiasts for personal use only. Unauthorised commercial use of this design, or any of its unique features, is expressly forbidden. Copyright ©Antenna and Electronic Consultancy Co. Ltd 2000. All rights reserved. This document may be freely copied in any form within the amateur radio community, stored on electronic media (including web sites) and disseminated. It may NOT be published in any profit-making periodical, book, magazine or other publication without the prior written consent of Antenna and Electronic Consultancy Co. Ltd (Antec / G8CKN). This document shall not be sold - it must only be given away.

This is the original issue of the document (minor text amendments made this version 1a). This document was created by G1MFG (see <http://www.G1MFG.com>) with permission from Antec / G8CKN.

Performance

Forward gain as a function of frequency

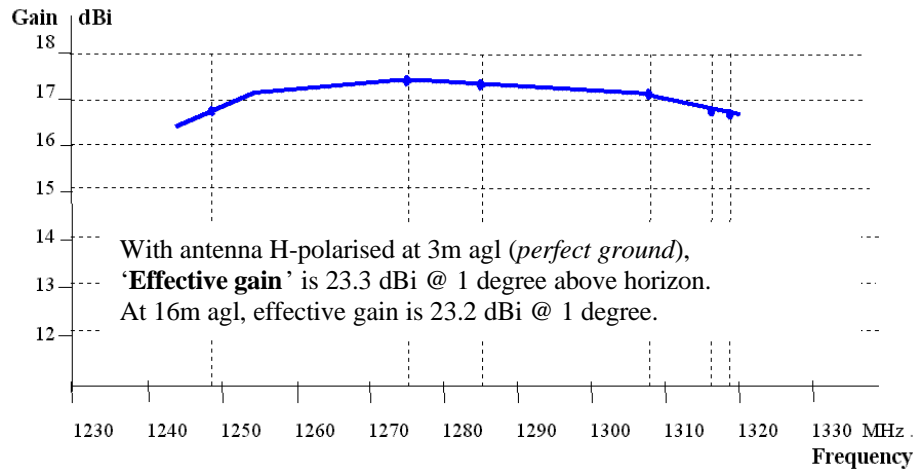

VSWR as a function of frequency

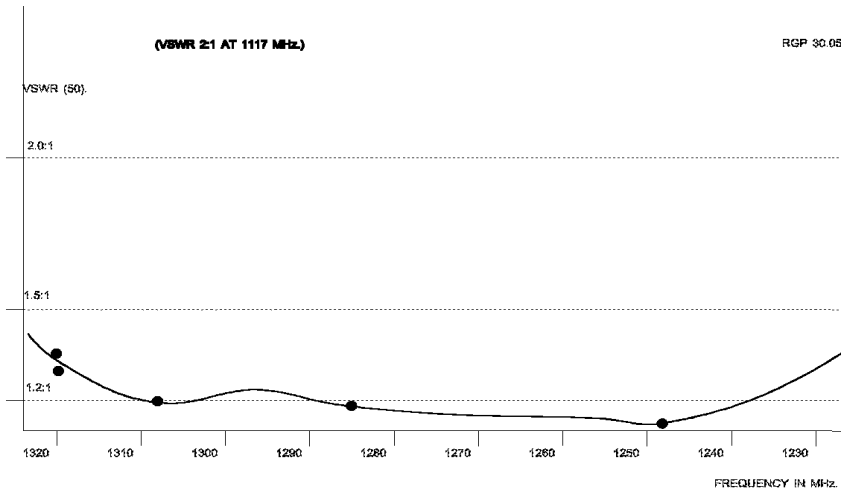

Radiation pattern - horizontal

E-PLANE PLOT

NORMALIZED AT 17.41 DBI

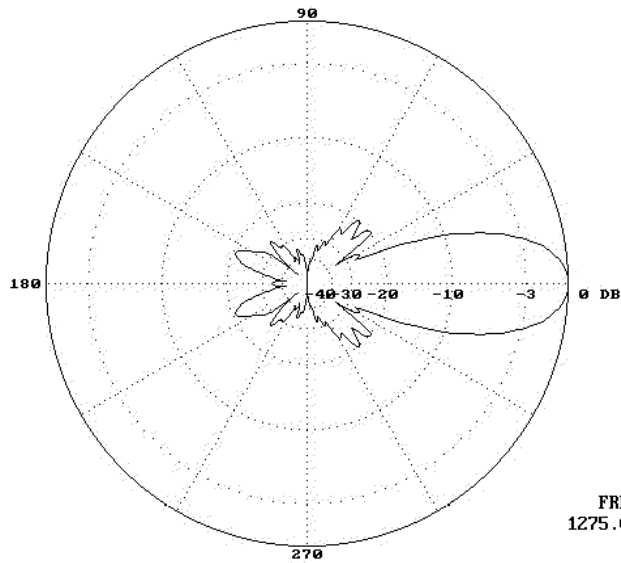

Radiation pattern - vertical

H-PLANE PLOT

NORMALIZED AT 23.33 DBI
 AT ELEVATION 1.0 DEG
 HEIGHT W/L
 13.000

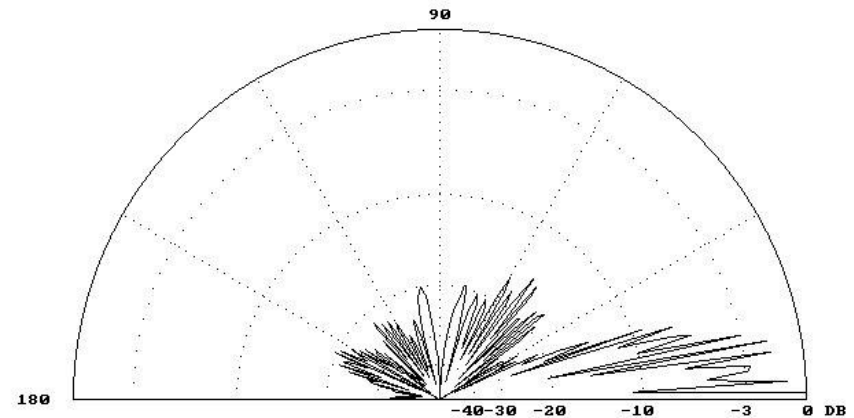

This plot shows the radiation pattern of the aerial over a perfect, fully conducting ground / earth plane. The actual pattern in use is likely to differ.

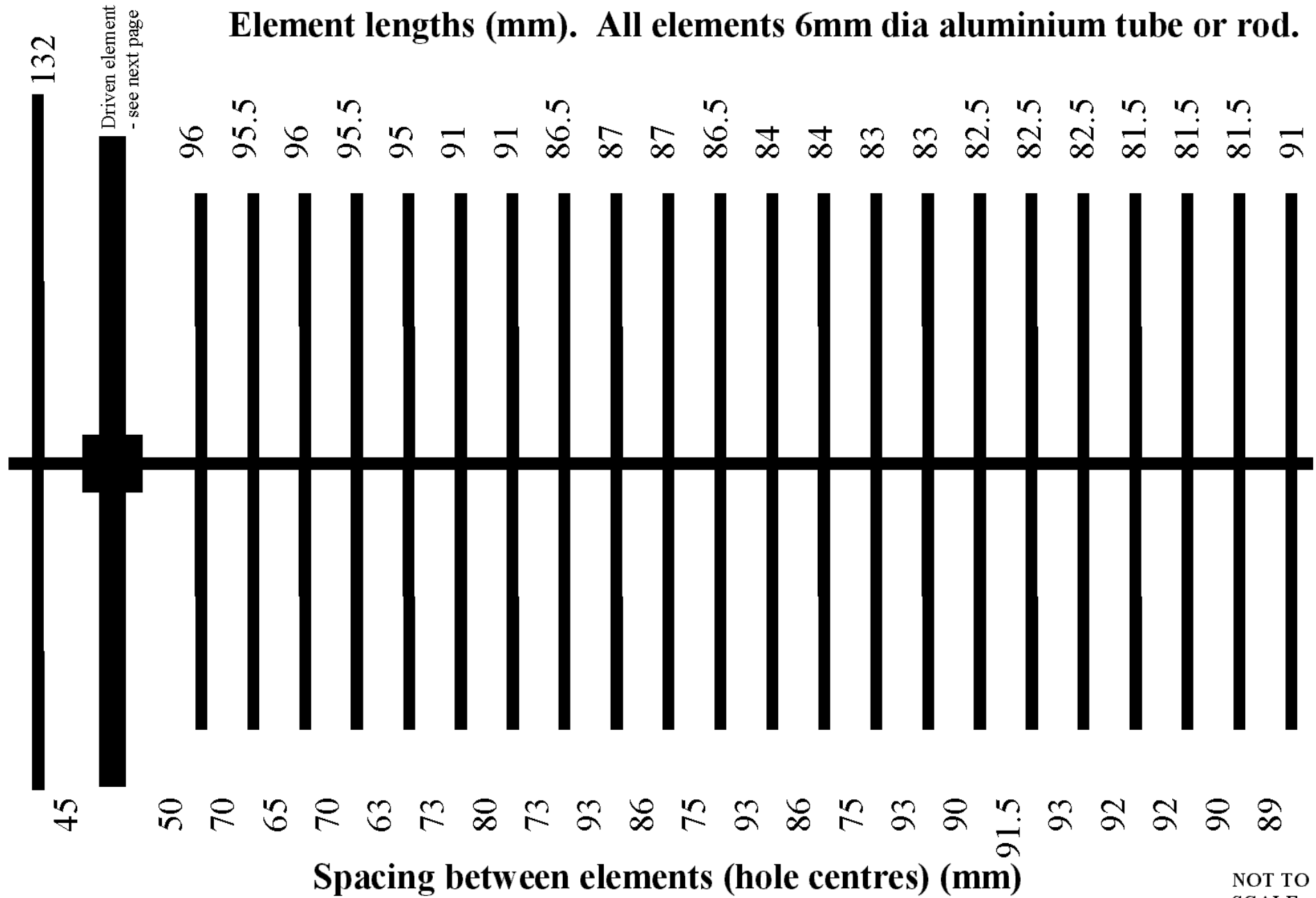

Boom material: 15mm square section aluminium, length approx 1950mm

NOT TO SCALE

Construction of balun box PCB

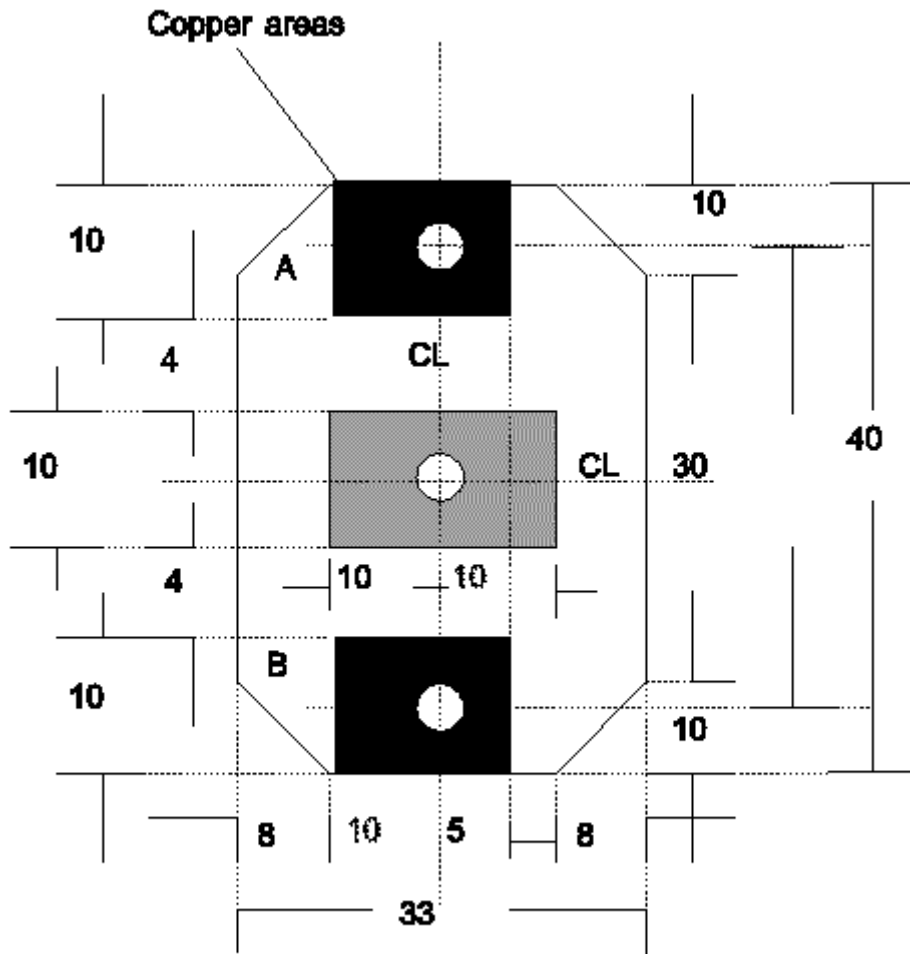

Holes 3mm.

All dimensions in mm.

You only need to remove the corners of the board if it is necessary to fit the board in the termination box.

NOT TO SCALE

Construction of driven element (folded dipole)

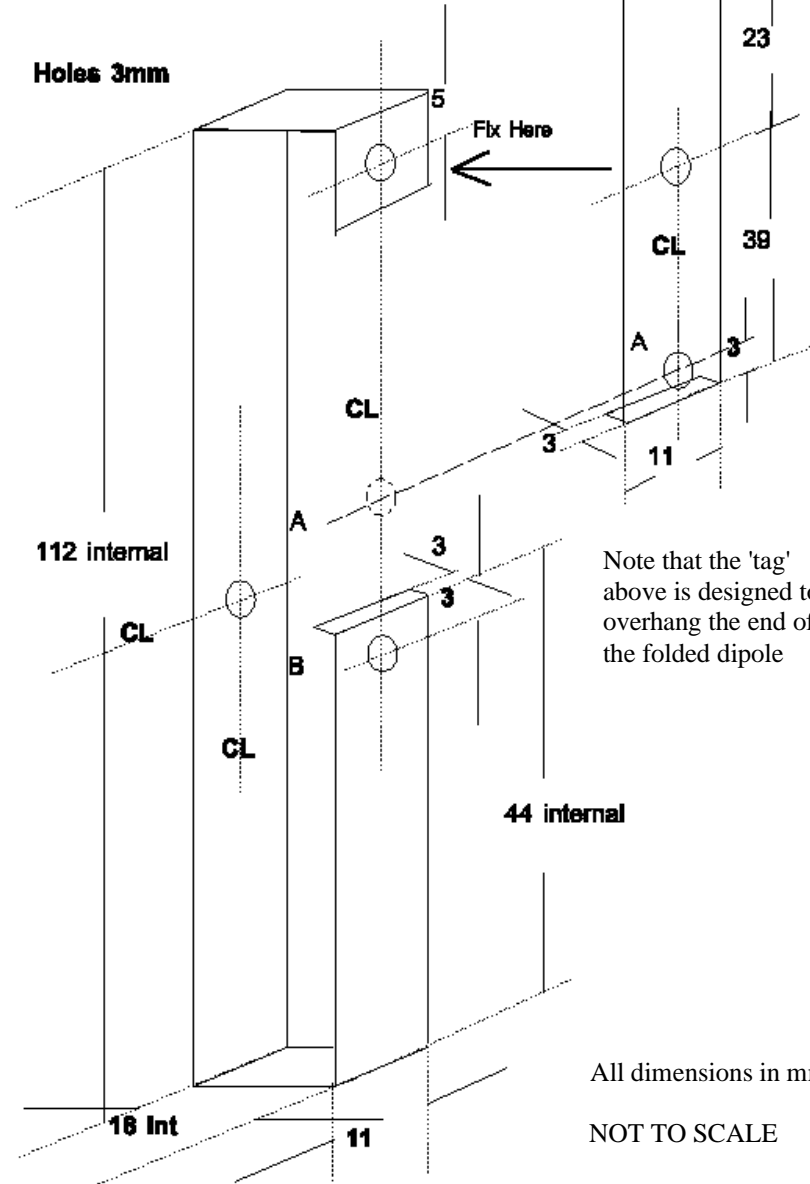

All dimensions in mm.

NOT TO SCALE

Construction of balun cable

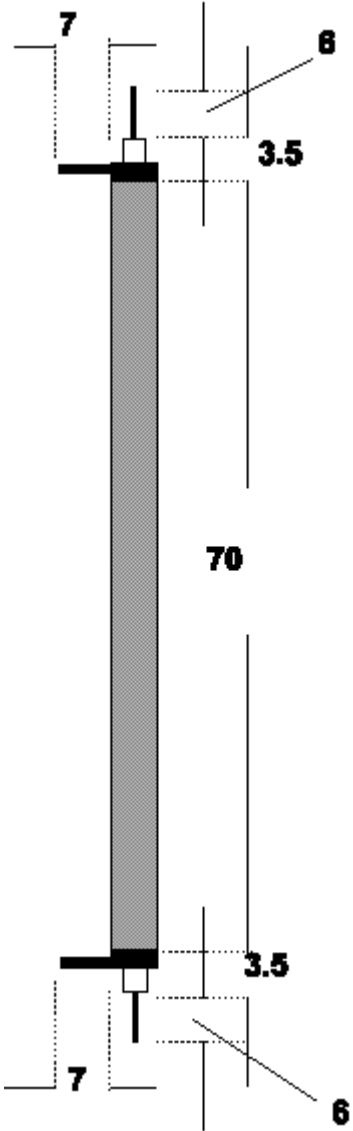

Material: RG58 50 ohm co-ax

All dimensions in mm. NOT TO SCALE.

Construction of balun box

